

REV.	ECN NO.	MODIFY MATTER	DATE	APPROVED
A		RELEASE TO PRODUCTION		

DATE CODE YYMMDD
 DD: DAY
 MM: MONTH
 YY: YEAR

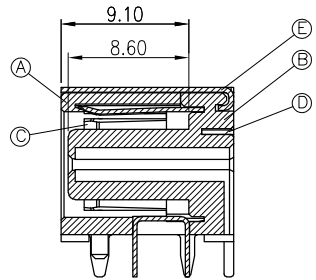

SECTION A-A
SCALE 1:1

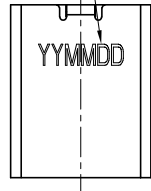
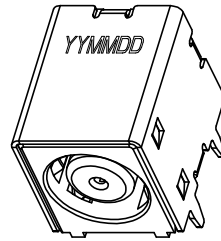

SPECIFICATIONS:

- ELECTRICAL CHARACTERISTICS:
 - RATING: 20V 10A
 - CONTACT RESISTANCE: 30mΩ MAX.(INITIAL)
 - DIELECTRIC WITHSTANDING VOLTAGE: 500V AC FOR ONE MINUTE.
 - INSULATION RESISTANCE: 100MΩ MIN. MEASURED BY 250 VDC
- MECHANICAL CHARACTERISTICS:
 - INSERTION FORCE : 3.0 KGF Max.
 - WITHDRAWAL FORCE : 0.35 KGF Min.
- LIFE TEST: 5,000 CYCLES MIN.
- TO CONFORM TO SINGATRON HAZARDOUS SUBSTANCE FREE SPEC.

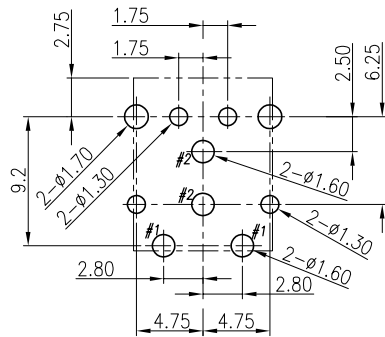
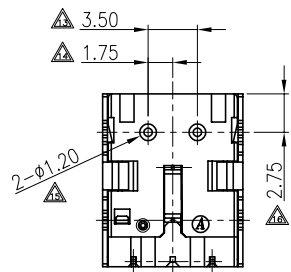
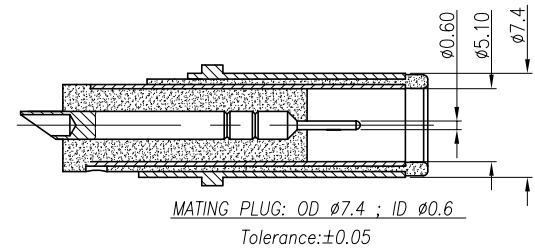
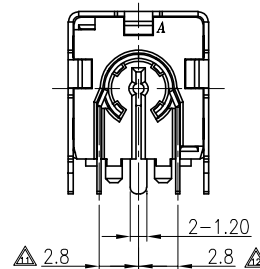
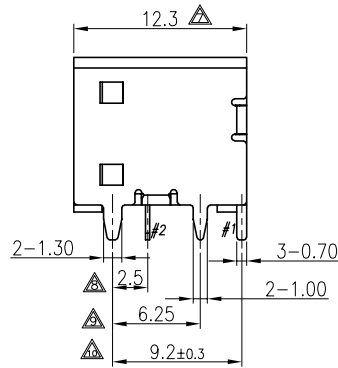
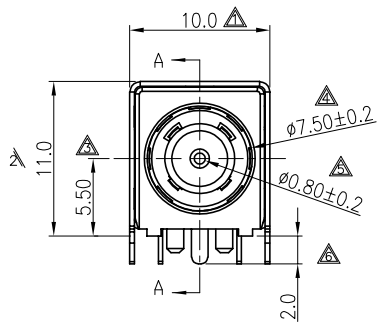

RECOMMENDED P.C.B LAYOUT
TOP VIEW (TOLERANCE: ±0.05)

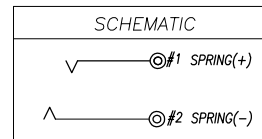

TOLERANCES UNLESS OTHERWISE SPECIFIED: X. --- X. X ± 0.38 X. XX ± 0.25 X. XXX ± 0.10 Angle ± 1°	CUSTOMER COPY	深圳市东方御业科技有限公司 WWW.DFYCONN.COM TEL:0755-27155560		
	DRAWN: CHENLEI	2017/09/10	TITLE: DC-JACK	
THESE DRAWING AND SPECIFICATION ARE THE PROPERTY OF Shenzhen Dongfangyuye ELECTRONIC CO., LTD. SHALL NOT BE REPRODUCED.	CHECKED: CHENLEI	2017/09/10	PART NO: EAST-D053A	DRAWING NO: (RoHS)
	APPROVED: QINKAIXING	2017/09/10	UNIT: mm	SCALE: N/A
			SHEET: 1:1	REV.

REV.	ECN NO.	MODIFY MATTER	DATE	APPROVED
A		RELEASE TO PRODUCTION		

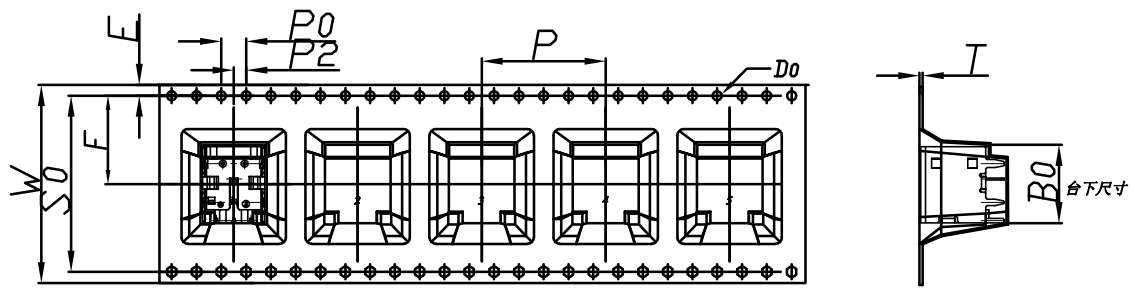

ITEM	W	A0	B0	Do	E	F	S0	K0	P0	P2	P	T
DIM	32	10.60	12.67	1.5	1.75	14.2	28.4	14.00	4.0	2.0	20.0	0.5
TOLE	±0.30	±0.15	±0.15	±0.10	±0.10	±0.10	±0.10	±0.15	±0.10	±0.15	±0.10	±0.05

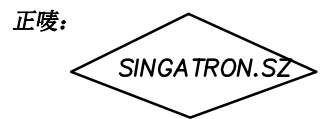
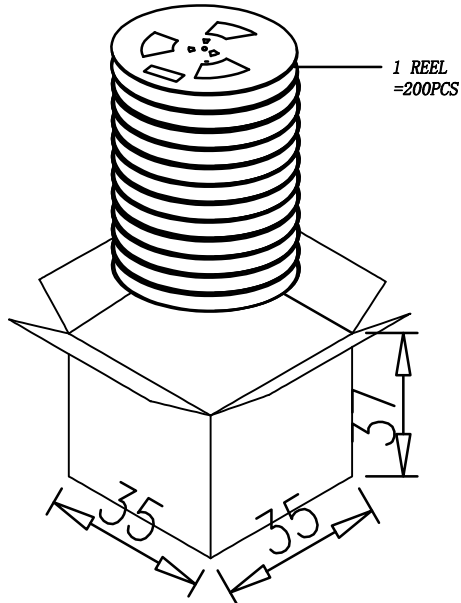
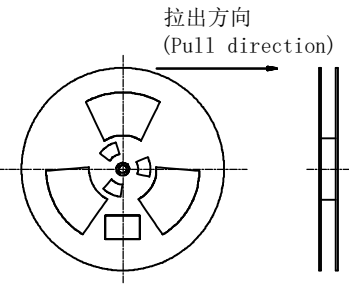
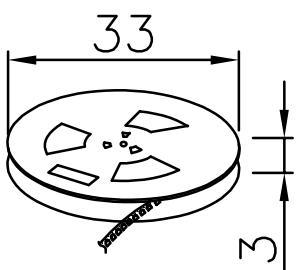

C/NO:
MADE IN CHINA

侧唛:
ITEM NO:
Q'TY: PCS
N.W.: KGS
G.W.: KGS

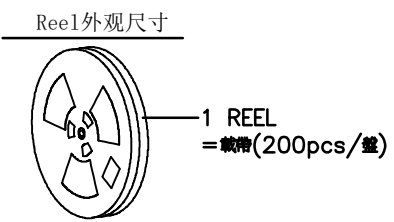

1. 包装数量: 200PCS/卷.
2. 外包装规格: 35*35*37cm.
3. 每箱里面套一个防水袋

PACKAGE INFORMATION			
PART NUMBER	Q'TY PER REEL	REEL PER BOX	Q'TY PER BOX
DJ-D053	200 PCS	10 R	2000 PCS

TOLERANCES UNLESS OTHERWISE SPECIFIED: X. — X.X ± 0.38 X.XX ± 0.25 X.XXX ± 0.10 Angle ± 1°		COSTOMER COPY		深圳市东方御业科技有限公司 WWW.DFYCONN.COM TEL:0755-27155560	
DRAWN: CHENLEI		2017/09/10		TITIAL: DC-JACK	
CHECKED: CHENLEI		2017/09/10		PART NO: EAST-D053	
APPROVED: QINKAIXING		2017/09/10		DRAWING NO: (RoHS)	
THESE DRAWING AND SPECIFICATION ARE THE PROPERTY OF Shenzhen Dongfangyue ELECTRONIC CO., LTD.. SHALL NOT BE REPRODUCED.		UNIT: mm		SCALE: N/A	
				SHEET: 1:1	
				REV.	