

REV.	ECN NO.	MODIFY MATTER	DATE	APPROVED
A		RELEASE TO PRODUCTION		

**NOTES:**

**\*Material**

Housing: Nylon66+30%G.F, UL 94V-0 Rated, Color:Black.  
 Contact: Brass.  
 Plating: Au plating on contact area,Sn(100u" Min.)plating on solder tail, Ni(40u" Min.)underplating overall.  
 Harpoon: Brass.  
 Plating: Sn(100u" Min.)plating over Ni(40u" Min.).

**\*Electrical Specification**

Operation Voltage: 100V AC Max.  
 Current Rating: 1.5 Ampere per contact.  
 Contact Resistance: 30mΩ Max.  
 Insulation Resistance: 1000MΩ Min.  
 Dielectric Withstanding Voltage: 500V AC.

**\*Mechanical Performance**

Insertion Force: 45N Max.  
 Withdrawal Force: 10N Min.  
 Durability: 500 Cycles.

**\*ORDER INFORMATION:\***

EAST-014 X 01 XX X X

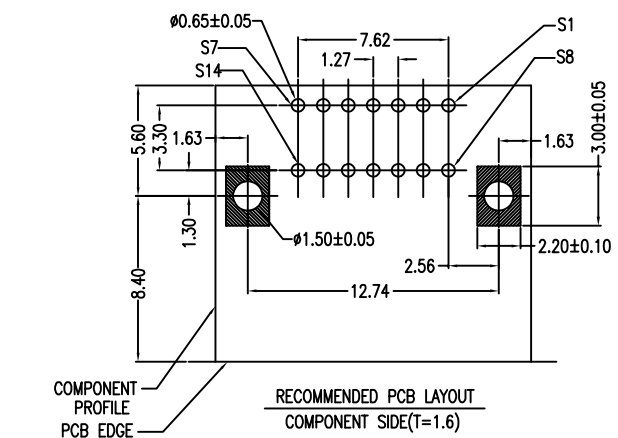
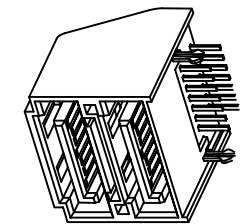
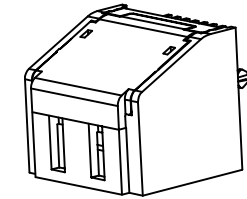
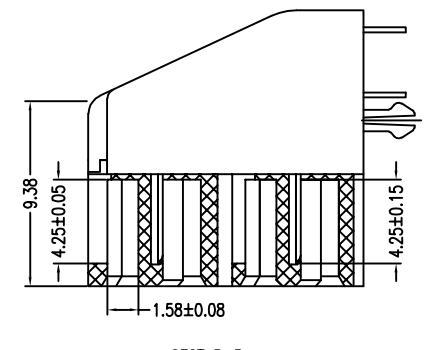
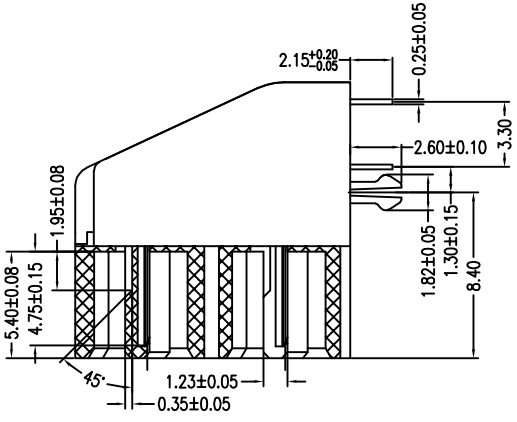
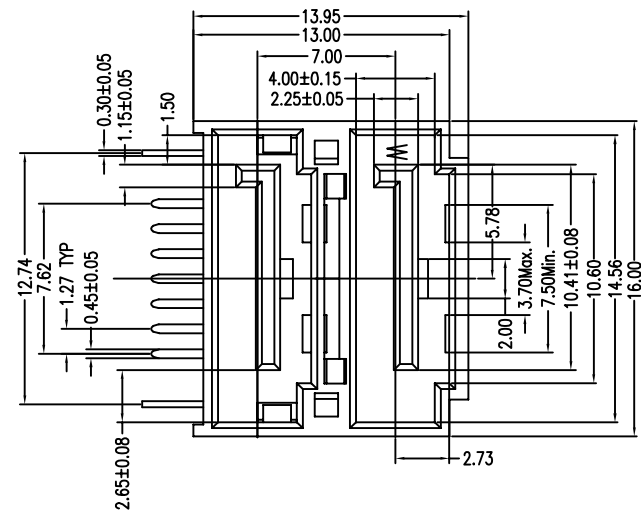
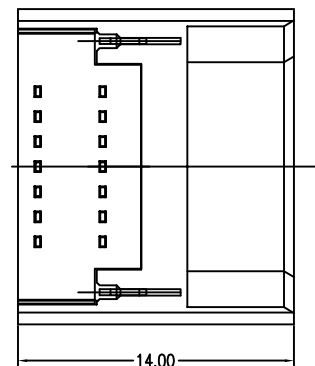
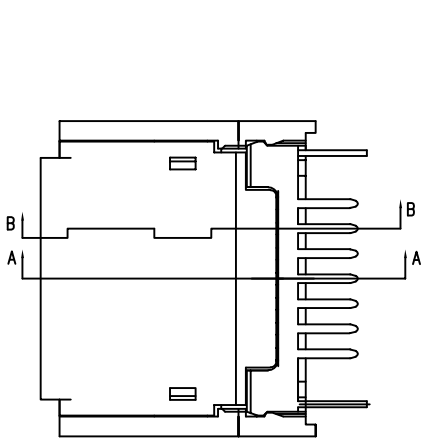
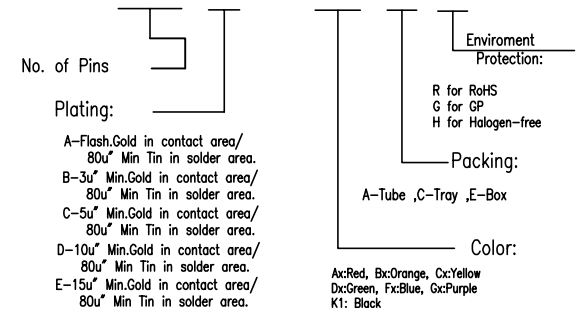

Signal Segment	
Name	Type
S1	GND
S2	A+
S3	A-
S4	GND
S5	B-
S6	B+
S7	GND

TOLERANCES UNLESS OTHERWISE SPECIFIED: X. --- X.X ± 0.38 X.XX ± 0.25 X.XXX ± 0.20 Angle ± 3°	COSTUMER COPY	深圳市东方御业科技有限公司 WWW.DFYCONN.COM TEL:0755-27155560	
	DRAWN: <b>Qinx</b>	2017/09/10	TITLE: 双层SATA 7P顶部开窗DIP
THESE DRAWING AND SPECIFICATION ARE THE PROPERTY OF Shenzhen Dongfangyue ELECTRONIC CO., LTD. SHALL NOT BE REPRODUCED.	CHECKED: <b>Chenl</b>	2017/09/10	PART NO: EAST-014A01K1AR
	APPROVED: <b>Chenl</b>	2017/09/10	UNIT: mm SCALE: N/A SHEET: REV.