

RECOMMENDED PCB LAYOUT
TOP VIEW; TOL.±0.05

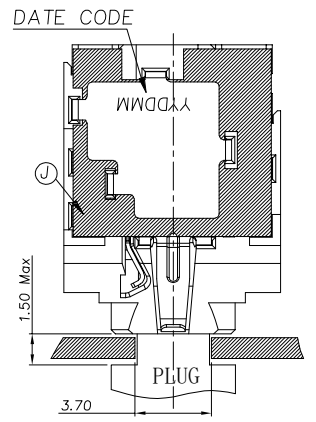
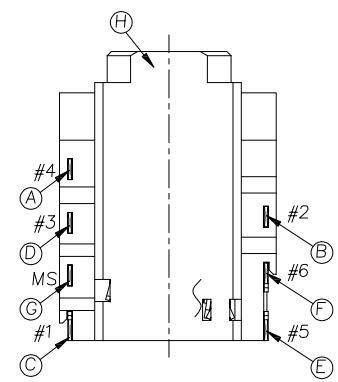

RECOMMENDED PANEL'S ID
TOP VIEW; TOL.±0.05

REV.	ECN NO.	MODIFY MATTER	DATE	APPROVED
A		RELEASE TO PRODUCTION		

- SPECIFICATION:**
- Electrical characteristics
 - Rating: 12V 1A.
 - Contact resistance: 50mΩ Max. (Initial)
After test: 60mΩ Max.
 - Insulation resistance: 100MΩ Min(500V DC).
 - Withstanding voltage: 500V AC.
 - Mechanical characteristics
 - Life test: 5000 cycles
 - Mating /Unmating force: 3-30N
 - Salt Spray: 8hours
 - Wave Solder 265° C, 3-5 sec.
IR Reflow, Peak Temp 230-250° C, 20-90 sec.

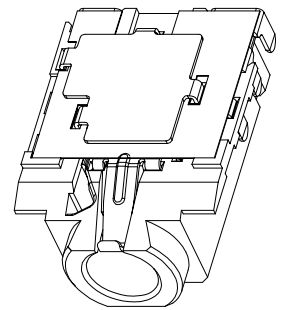

EAST-2310I-07FX-BPA
 B:BLACK
 P:PINK(#199C)
 G:GREEN(#577C)

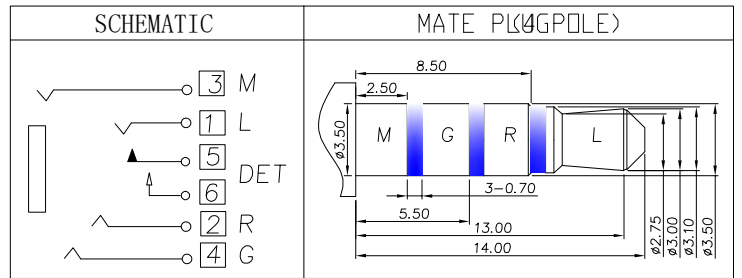

NO.	DESCRIPTION	FOOT	QTY	MATERIAL	REMARK
J	Mylar		1	0.1t	Yellow
I	Insert Molding		1	LCP	Black,UL94 V-0
H	Housing		1	PA9T	Black,UL94 V-0
G	Shell	MS	1	C5210,T0.20	Nickel Plating All Over;
F	Contact 6	6#	1	C5210,T0.20	Gold flash on contact area; Solder tail tin plating 50u"Min; Nickel plating 40u"Min for all;
E	Contact 5	5#	1	C5210,T0.20	
D	Contact 2	3#	1	C5210,T0.20	
C	Contact 4	1#	1	C5210,T0.20	
B	Contact 3	2#	1	C5210,T0.20	
A	Contact 1	4#	1	C5210,T0.20	

TOLERANCES UNLESS OTHERWISE SPECIFIED: X. --- X.X ± 0.38 X.XX ± 0.25 X.XXX ± 0.10 Angle ± 1°		CUSTOMER COPY	深圳市东方御业科技有限公司 WWW.DFYCCONN.COM TEL:0755-27155560	
DRAWN: CHENLEI	2017/09/10	TITIAL: AUDIO JACK (RoHS)		
CHECKED: CHENLEI	2017/09/10	PART NO: EAST-2310I-07FX-BPA		
APPROVED: QINKAIXING	2017/09/10	UNIT: mm	SCALE: N/A	SHEET: 1:1

REV.	ECN NO.	MODIFY MATTER	DATE	APPROVED
A		RELEASE TO PRODUCTION		

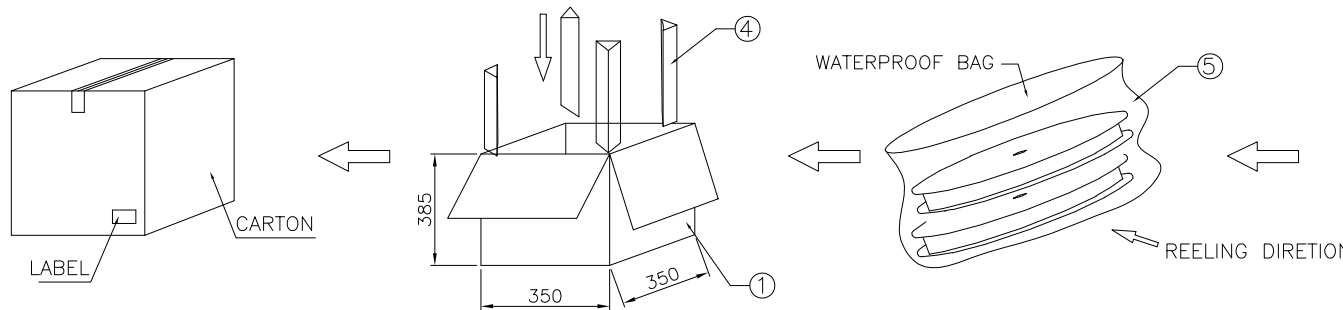
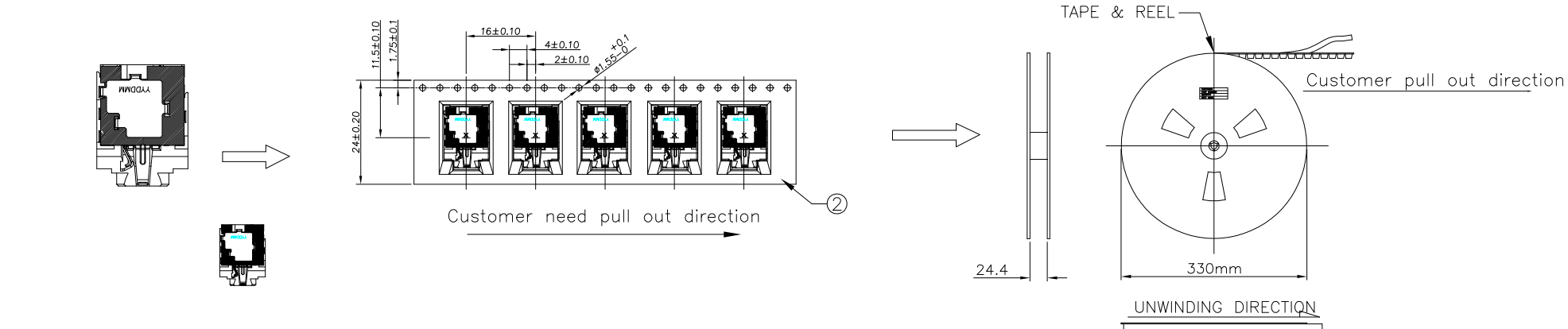

QUANTITY		
PCS /REEL	REEL /CARTON	PCS /CARTON
500	13	6500

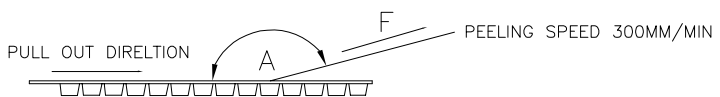
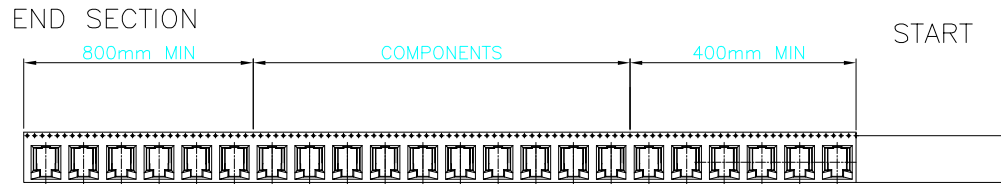

COVER TYPE PEELING FORCE	
A	165°-180°
F	0.1N-1.3N

ITEM	MATERIAL	FINISH	Q'TY	NOTE
⑤	WATERPROOF BAG		1	
④	SUPPORT BRACE		4	
③	REEL ASS'Y		13	
②	CARRIER TAPE		13	
①	CARTON		1	

TOLERANCES UNLESS OTHERWISE SPECIFIED: X. --- X.X ± 0.38 X.XX ± 0.25 X.XXX ± 0.10 Angle ± 1°		COSTOMER COPY		深圳市东方御业科技有限公司 WWW.DFYCONN.COM TEL:0755-27155560	
THESE DRAWING AND SPECIFICATION ARE THE PROPERTY OF Shenzhen Dongfangyuye ELECTRONIC CO., LTD.. SHALL NOT BE REPRODUCED.		DRAWN: CHENLEI CHECKED: CHENLEI APPROVED: QINKAIXING	2017/09/10 2017/09/10 2017/09/10	TITIAL: AUDIO JACK (RoHS) PART NO: EAST-2310I-07FX-BPA UNIT: mm SCALE: N/A SHEEL: 1:1 REV.	