

- *Material:
- Housing: PA66+30%G/F,UL-HB;
 - Terminal: Brass,T=0.25mm;
Plating: Gold in contact area;
80u" Min Tin in solder area;
30u" MIN.NICKEL UNDERPLATING OVER ALL.
 - Fork: SPCC, NICKEL UNDERPLATING OVER ALL.
 - Shell: STAINLESS STEEL,
NICKEL UNDERPLATING OVER ALL.

- *Electrical Characteristics:
- Contact Resistance: 30mΩ Max.
 - Insulation Resistance: 1000MΩ Min.
 - Dielectric Strength: 500V DC/1MIN.
 - Contact Current rating: 1.1 A Per Pin Min.

- *Mechanical Characteristics:
- Insertion Force: 1.15N per contact pair Max.
 - Extraction Force: 0.15N per contact pair Min.
 - Durability rating: 50 Cycles

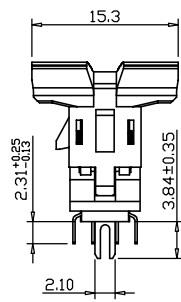
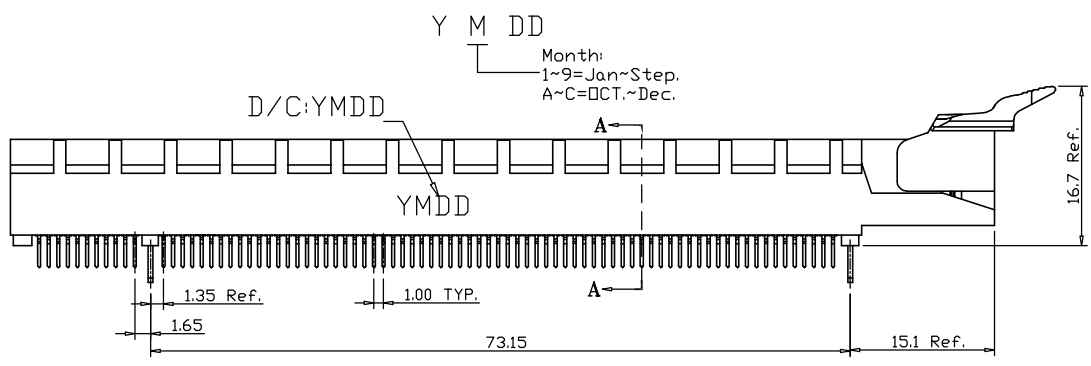

ORDER INFORMATION:

EAST-164 01 X 89 XX C R

No. of Pins: _____

Plating: _____

Environment Protection:
R For RoHS
G For GP
H For Halogen-free

Packing:
A-Tube, C-Tray, E-Box

HSG Color:
Ax:Red, Bx:Orange, Cx:Yellow,
Dx:Green, Fx:Blue, Hx:Gray,
K1:Black, L1:White

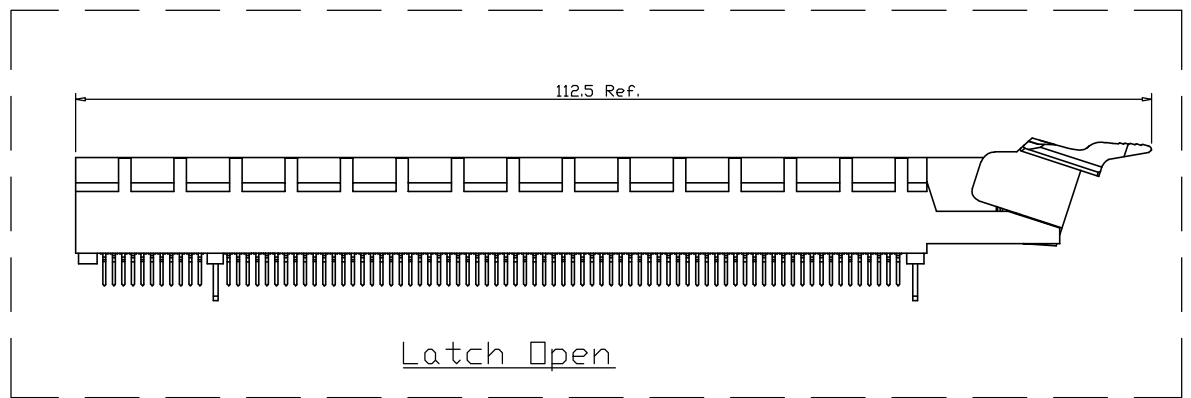

| TOLERANCE | | 深圳市东方御业科技有限公司 WWW.DFYCONN.COM TEL:0755-27155560 | TITLE: PCIe 164P Slot大耳扣旋转式 带屏蔽壳-A款 | | | | |
|------------|----------|--|--|-----------|----------------|----------|-----|
| LINEAR | ANGLES | | CUSTOMER | PART NO.: | COPY | DWG NO.: | |
| X.±0.50 | X°.±2.0° | | | | EAST-180726-02 | | |
| .X ±0.38 | .X°±1.0° | | | | | | |
| .XX ±0.25 | .XX°± | APPD: | DRWN: Rocky | UNITS | SCALE | SHEET | REV |
| .XXX ±0.15 | .XXX°± | CHKD: | DATE: 2017-7-26 | MM | 1:1 | 1 OF 3 | A/0 |

| | | | | |
|-----|-----|-------------|------|-----|
| REV | LTR | DESCRIPTION | DATE | DWN |
|-----|-----|-------------|------|-----|

With Shell

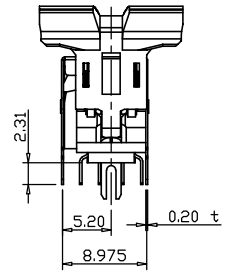
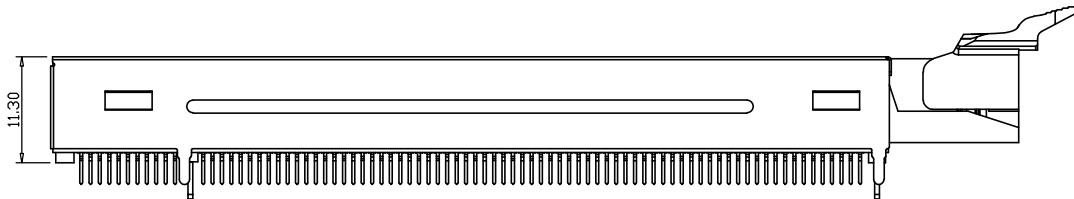
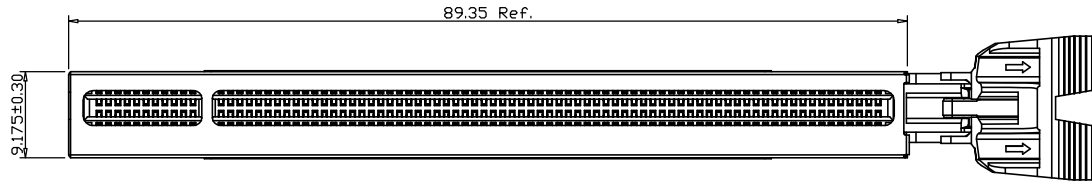
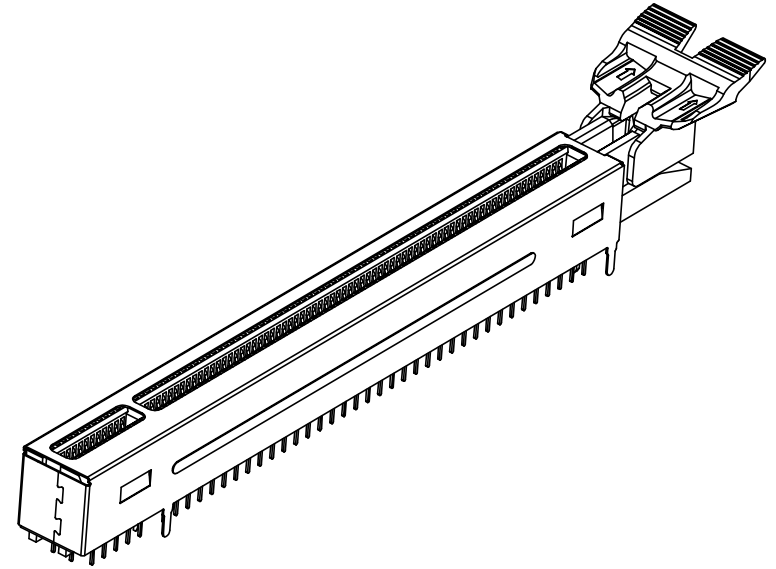
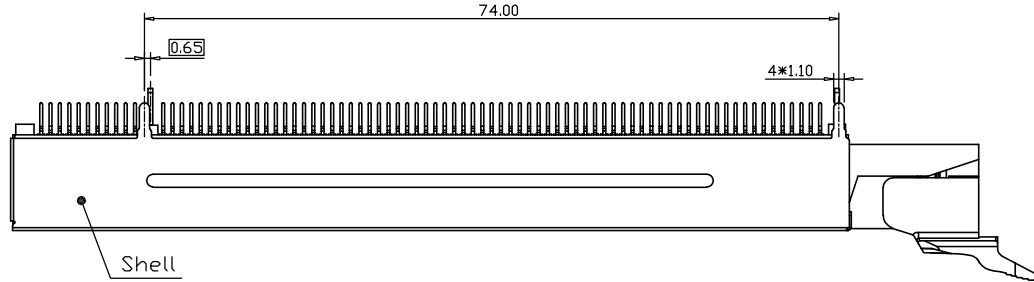

| TOLERANCE | | 深圳市东方御业科技有限公司 | | TITLE: PCIe 164P Slot大耳扣旋转式带屏蔽壳-A款 | | | |
|------------|-----------|-----------------------------------|-----------------|------------------------------------|-------------------------|--------|-----|
| LINEAR | ANGLES | www.DFYCONN.COM TEL:0755-27155560 | | CUSTOMER | PART NO.: | | |
| X ±0.50 | X° ±2.0° | | | CPY | DWG NO.: EAST-180726-02 | | |
| .X ±0.38 | .X° ±1.0° | APPD: | DRWN: Rocky | UNITS | SCALE | SHEET | REV |
| .XX ±0.25 | .XX° ± | CHKD: | DATE: 2017-7-26 | MM | 1:1 | 3 OF 4 | A/0 |
| .XXX ±0.15 | .XXX° ± | | | | | | |

| | | | | |
|-----|-----|-------------|------|-----|
| REV | LTR | DESCRIPTION | DATE | DWN |
|-----|-----|-------------|------|-----|

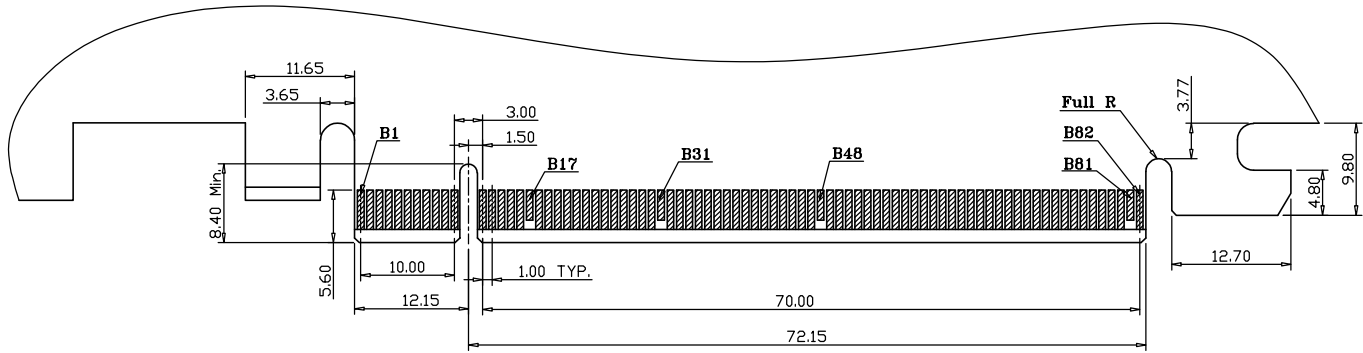

RECOMMENDED EDGE CARD PATTERN<PRIMARY SIDE>

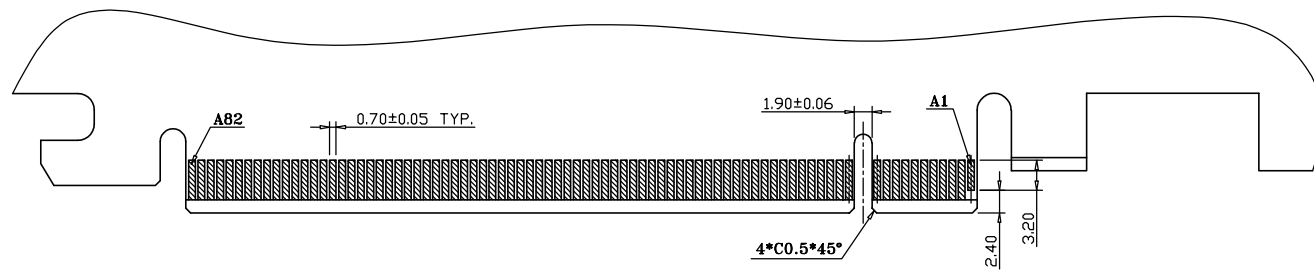
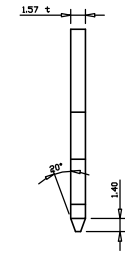

RECOMMENDED EDGE CARD PATTERN<SECONDARY SIDE>

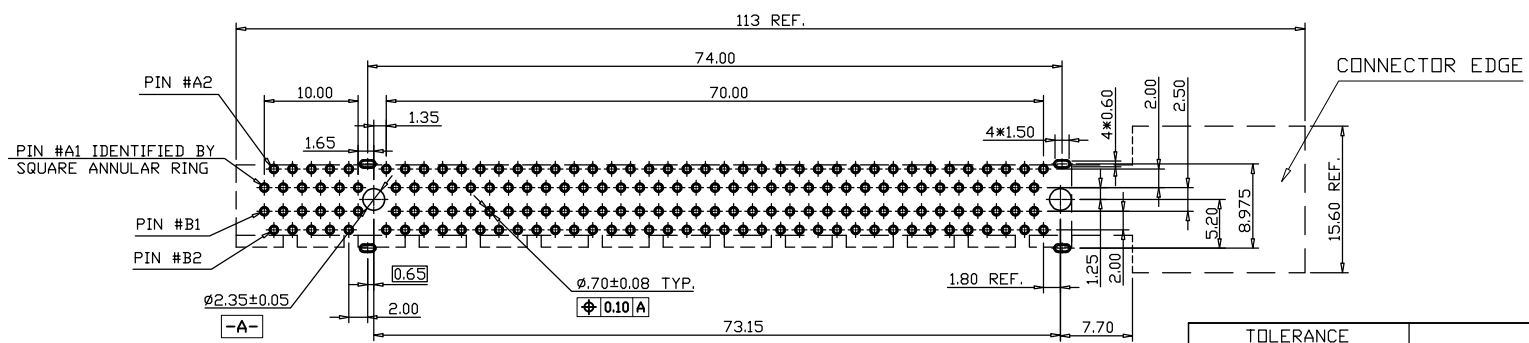

RECOMMENDED PCB LAYOUT <COMPONENT SIDE>
TOLERANCE: ±0.05

| | | | | | | | |
|------------|----------|--|-------------------------|------------------------------------|-----------|-------|-------|
| TOLERANCE | | 深圳市东方御业科技有限公司 WWW.DFYCONN.COM TEL:0755-27155560 | | TITLE: PCIe 164P Slot大耳扣旋转式带屏蔽壳-A款 | | | |
| LINEAR | ANGLES | | | CUSTOMER | PART NO.: | | |
| X.±0.50 | X*.±2.0° | DRWN: Rocky | DWG NO.: EAST-180726-02 | | | UNITS | SCALE |
| .X ±0.38 | .X*±1.0° | DATE: 2017-7-26 | MM | 1:1 | 2 OF 4 | SHEET | REV |
| .XX ±0.25 | .XX*± | CHKD: | MM | 1:1 | 2 OF 4 | A/0 | |
| .XXX ±0.15 | .XXX*± | | | | | | |