

REV.	ECN NO.	MODIFY MATTER	DATE	APPROVED
A		RELEASE TO PRODUCTION		

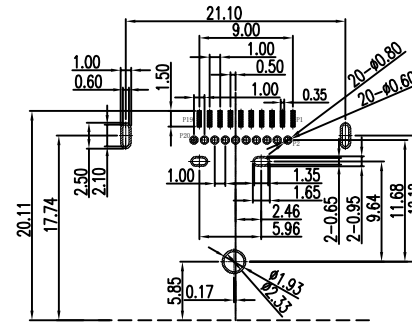
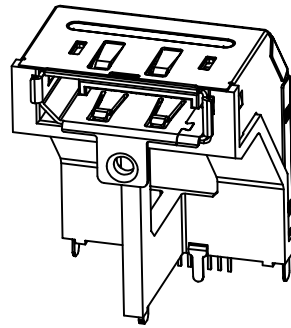
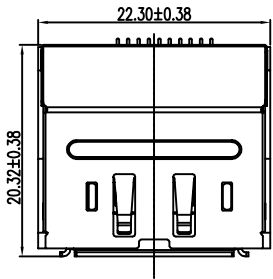

RECOMMENDED P.C.B. LAYOUT  
TOLERANCE±0.05  
TOP VIEW

### SPECIFICATION

- CURRENT RATING : 0.5A. MAX.
- DIELECTRIC WITHSTANDING VOLTAGE : 500V AC R.M.S. FOR ONE MINUTE.
- INSULATION RESISTANCE : 100MΩ MIN. AT 500V DC
- CONTACT RESISTANCE : 30mΩ MAX.
- OPERATING TEMPERATURE : -25°C TO +85°C.
- DURABILITY : 10000 CYCLES.
- MATING FORCE : 4.5kgf MAX.
- UNMATING FORCE : 1.0kcf MIN.

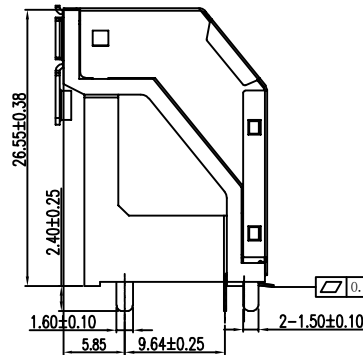
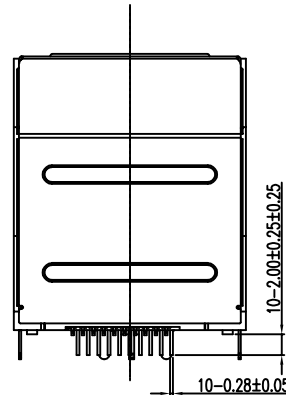
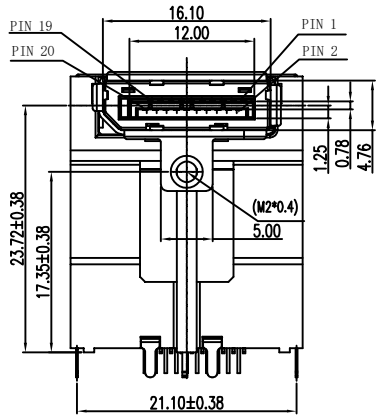

### MATERIALS

- HOUSING : LCP (UL94V-0),BLACK.
- BRACKET : LCP (UL94V-0),BLACK.
- TERMINAL: COPPER ALLOY  
GOLD PLATED ON CONTACT AREA, TIN PLATED ON SOLDER TAILS, NICKEL UNDER PLATED OVER ALL.
- SHELL: COPPER ALLOY, NICKEL PLATED OVERALL
- EMI SHELL(BACK): STAINLESS STEEL  
NICKEL PLATED OVERALL
- EMI SHELL(FRONT): STAINLESS STEEL.
- BOARD LOCK: BRASS, TIN PLATED OVERALL.

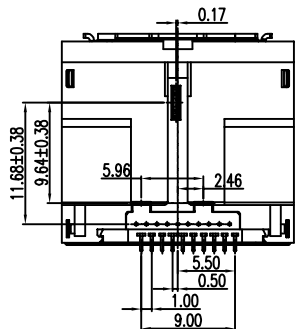

#### SOURCE SIDE

PIN NO.	PIN NAME
1	ML_Lane 0 (p)
2	GND
3	ML_Lane 0 (n)
4	ML_Lane 1 (p)
5	GND
6	ML_Lane 1 (n)
7	ML_Lane 2 (p)
8	GND
9	ML_Lane 2 (n)
10	ML_Lane 3 (p)
11	GND
12	ML_Lane 3 (n)
13	CONFIG1
14	CONFIG2
15	AUX CH (p)
16	GND
17	AUX CH (n)
18	Hot Plug Detect
19	Return
20	DP_PWP

#### SINK SIDE

PIN NO.	PIN NAME
1	ML_Lane 3 (n)
2	GND
3	ML_Lane 3 (p)
4	ML_Lane 2 (n)
5	GND
6	ML_Lane 2 (p)
7	ML_Lane 1 (n)
8	GND
9	ML_Lane 1 (p)
10	ML_Lane 0 (n)
11	GND
12	ML_Lane 0 (p)
13	CONFIG1
14	CONFIG2
15	AUX CH (p)
16	GND
17	AUX CH (n)
18	Hot Plug Detect
19	Return
20	DP_PWP

TOLERANCES UNLESS OTHERWISE SPECIFIED:  
X. ---  
X.X ± 0.38  
X.XX ± 0.25  
X.XXX ± 0.10  
Angle ±1°

THESE DRAWING AND SPECIFICATION ARE THE PROPERTY OF Shenzhen Dongfangyue ELECTRONIC CO., LTD.. SHALL NOT BE REPRODUCED.

COSTUMER COPY		深圳市东方御业科技有限公司 WWW.DFYCONN.COM TEL:0755-27155560	
DRAWN:	CHENLEI	2017/09/10	TITIAL: DISPLAYPORT FEMALE CONNECTOR HIGH RISE TYPE(H=23.72),DIP+SMT (RoHS)
CHECKED:	CHENLEI	2017/09/10	PART NO: EAST-DPH330A0008
APPROVED:	QINKAIXING	2017/09/10	DRAWING NO:
UNIT: mm	SCALE: N/A	SHEET: 1:1	REV.

REV.	ECN NO.	MODIFY MATTER	DATE	APPROVED
A		RELEASE TO PRODUCTION		

# 包裝圖

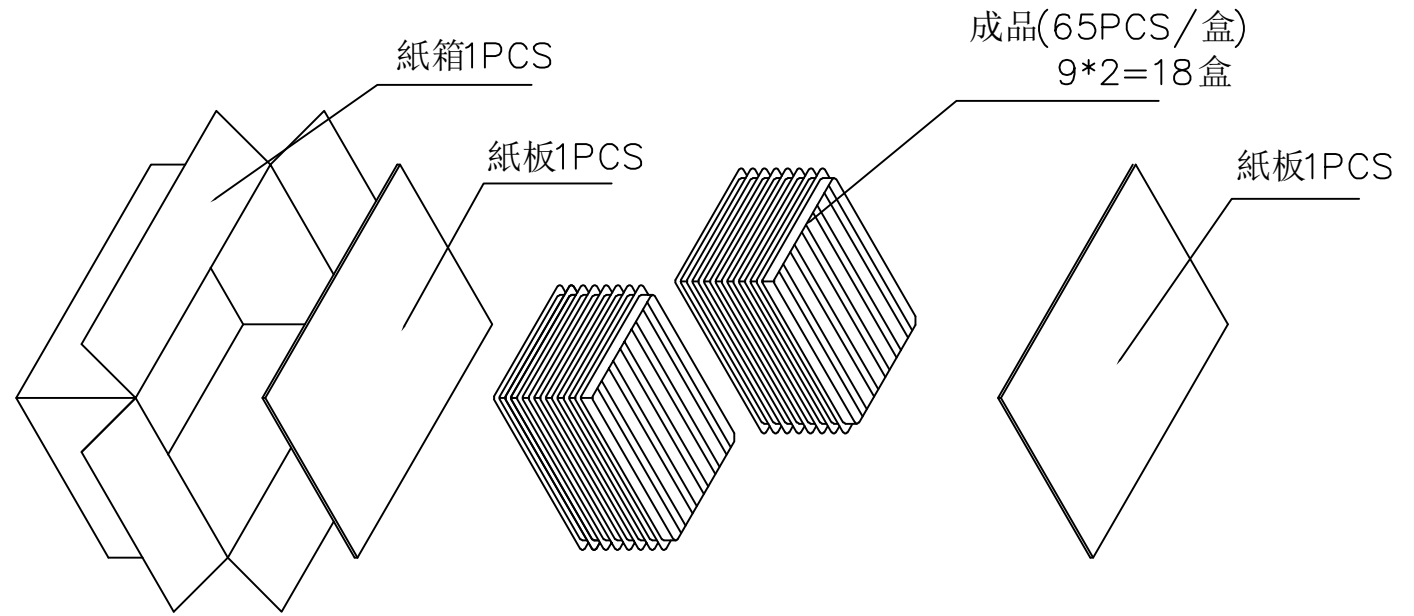

加厚紙箱: 45\*31\*22.5CM

EAST-DPH330A0008	X.XX	X.XX	65*18=1170
料 號	N.W: (KG)	G.W: (KG)	QT'Y(PCS)

TOLERANCES UNLESS OTHERWISE SPECIFIED: X. --- X.X ± 0.38 X.XX ± 0.25 X.XXX ± 0.10 Angle ±1°	COSTOMER COPY		<b>深圳市东方御业科技有限公司</b> WWW.DFYCONN.COM TEL:0755-27155560			
	DRAWN:	CHENLEI	2017/09/10	TITIAL: <b>DISPLAYPORT FEMALE CONNECTOR</b> <b>HIGH RISE TYPE(H=23.72),DIP+SMT</b> (RoHS)		
	CHECKED:	CHENLEI	2017/09/10	PART NO: EAST-DPH330A0008		DRAWING NO:
	APPROVED:	QINKAIXING	2017/09/10	UNIT: mm 	SCALE: N/A	SHEEL: 1:1

THESE DRAWING AND SPECIFICATION ARE THE PROPERTY OF Shenzhen Dongfangyue ELECTRONIC CO., LTD. SHALL NOT BE REPRODUCED.