

REV	LTR	DESCRIPTION	DATE	DWN

NOTE:
 1. MATERIAL:
 1.1. HOUSING: LCP HIGH TEMPERATURE THERMOPLASTIC, UL94V-0, COLOR: BLACK
 1.2. CONTACTS: COPPER ALLOY;
 1.3. PEG: COPPER ALLOY;
 2. REFLOW SOLDER CAPABLE TO 260°C
 3. FINISH:
 CONTACT: GOLD FLASH PLATE ON CONTACT AREA
 1.27um(50u")MIN NICKEL UNDERPLATE OVERALL
 PEG: 2.54um[100u"] MIN. MATTE-TIN.

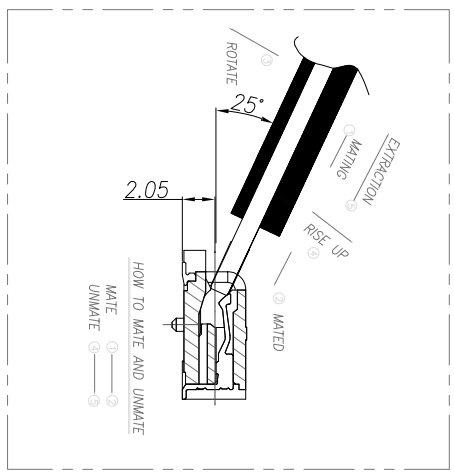
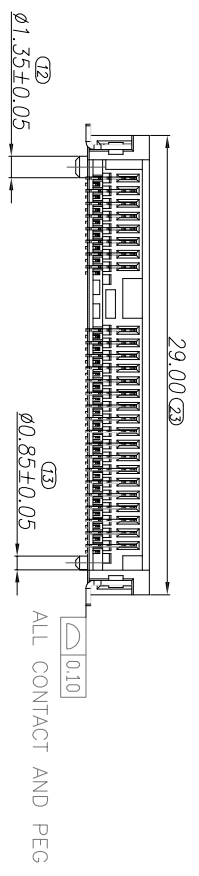
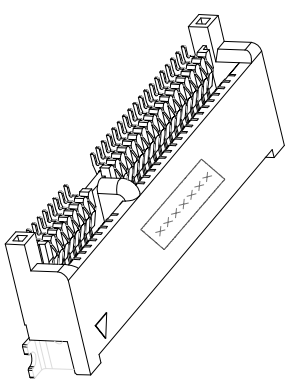
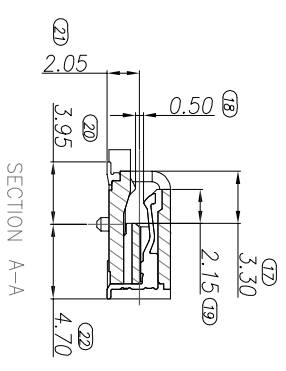
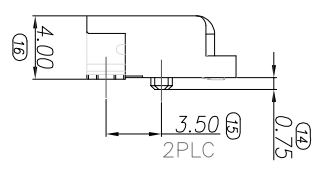
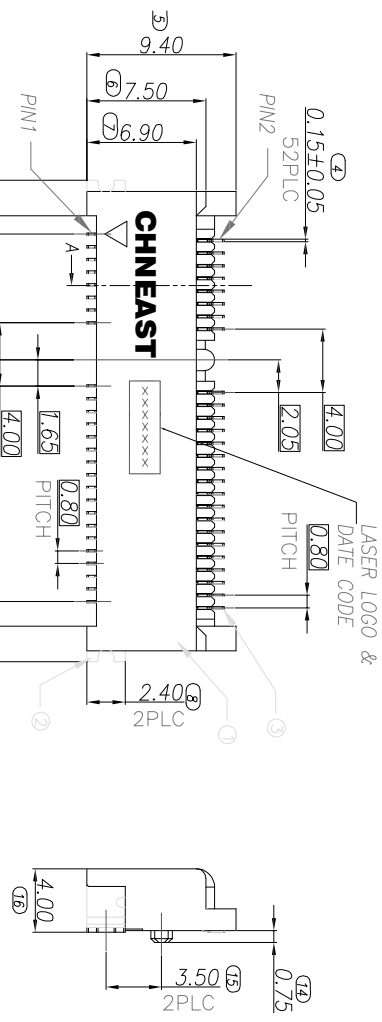
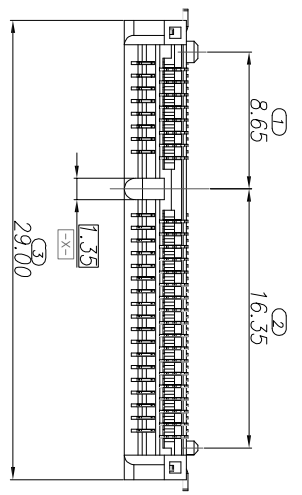

ITEM	NAME	QUANTITY
1	HOUSING	1 PCS
2	PEG	2 PCS
3	CONTACT	52 PCS

TITLE: Mini PCI EXPRESS 52P
 4.0H Connector

TOLERANCE	ANGLES	APPROX.	DATE:
X.±0.50	X°.±2.0°	DRVN: Revly	2012-8-1
X.±0.30	X°.±1.0°	CHKD:	
.XX±0.20	.XX°±		
.XXX±0.10	.XXX°±		

PART NO.	DWG NO.	UNITS	SCALE	SHEET	REV
		MM	1:1	1 OF 2	A/0

深圳市东方御业科技有限公司
 Tel:0755-27155560 www.dfyycn.com

SEE TABLE
 EAST-MX052P-40H

REV	LTR	DESCRIPTION	DATE	DWN
-----	-----	-------------	------	-----

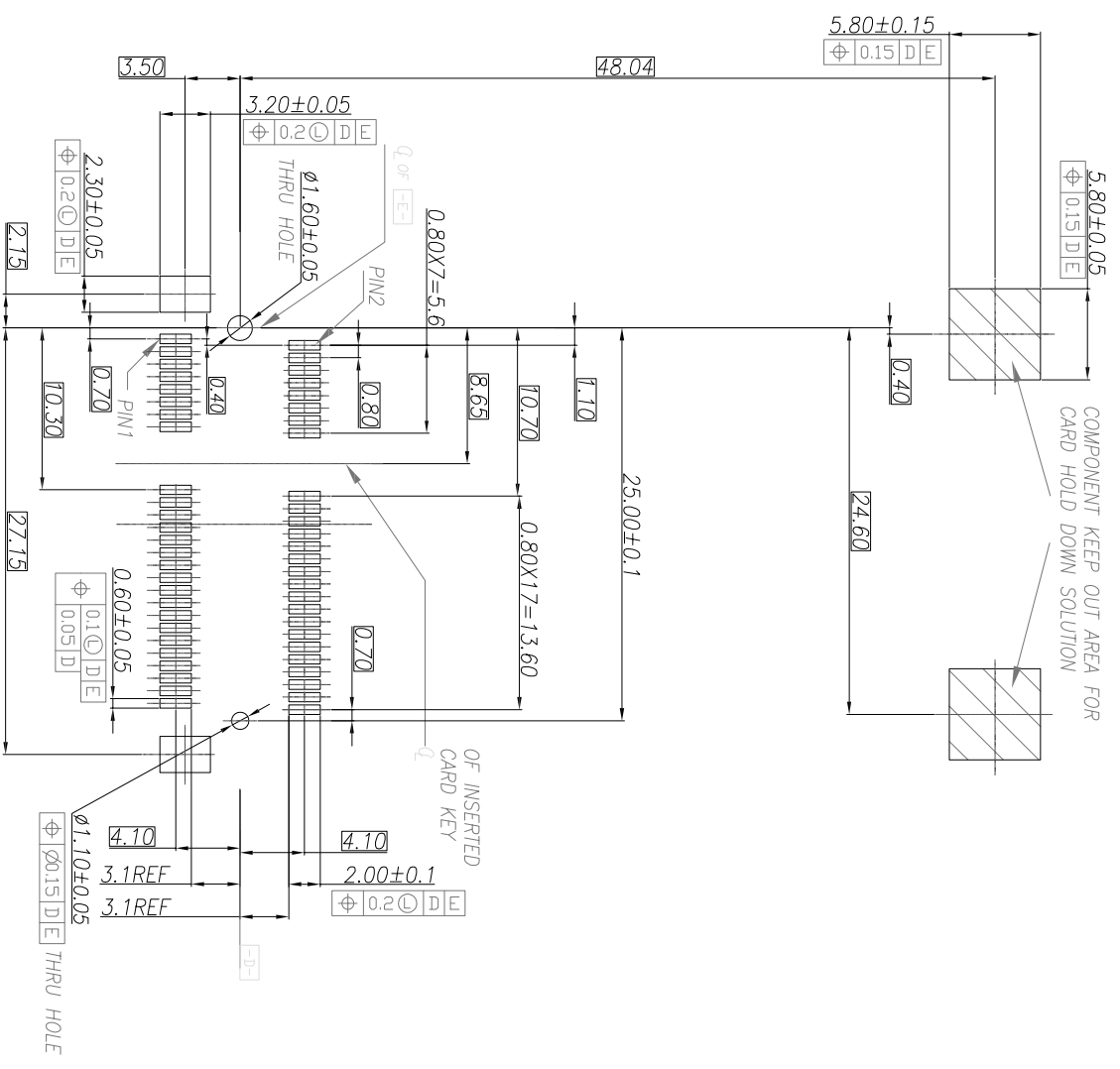

RECOMMENDED PCB LAYOUT

THICKNESS: 1.20±0.05mm

TOLERANCE		ANGLES		DRWN		DATE	
LINEAR	X ±0.50	ANGLES	X° ±2.0°	DRWN	Revly	DATE	2012-8-1
	X ±0.30		X° ±1.0°	APP'D			
	.XX ±0.20		.XX° ±	CHK'D			
	.XXX ±0.10		.XXX° ±				

深圳市东方御业科技有限公司
Tel: 0755-27155560 www.dfyycn.com

TITLE:	Mini PCI Express 59P
PART NO.	4.0H Connector
DWG NO.	SEE TABLE
UNITS	EAST-AXIS 59P-40H
SCALE	1:1
SHEET	1 OF 2
REV	A/0

REV	LTR	DESCRIPTION	DATE	DWN
-----	-----	-------------	------	-----

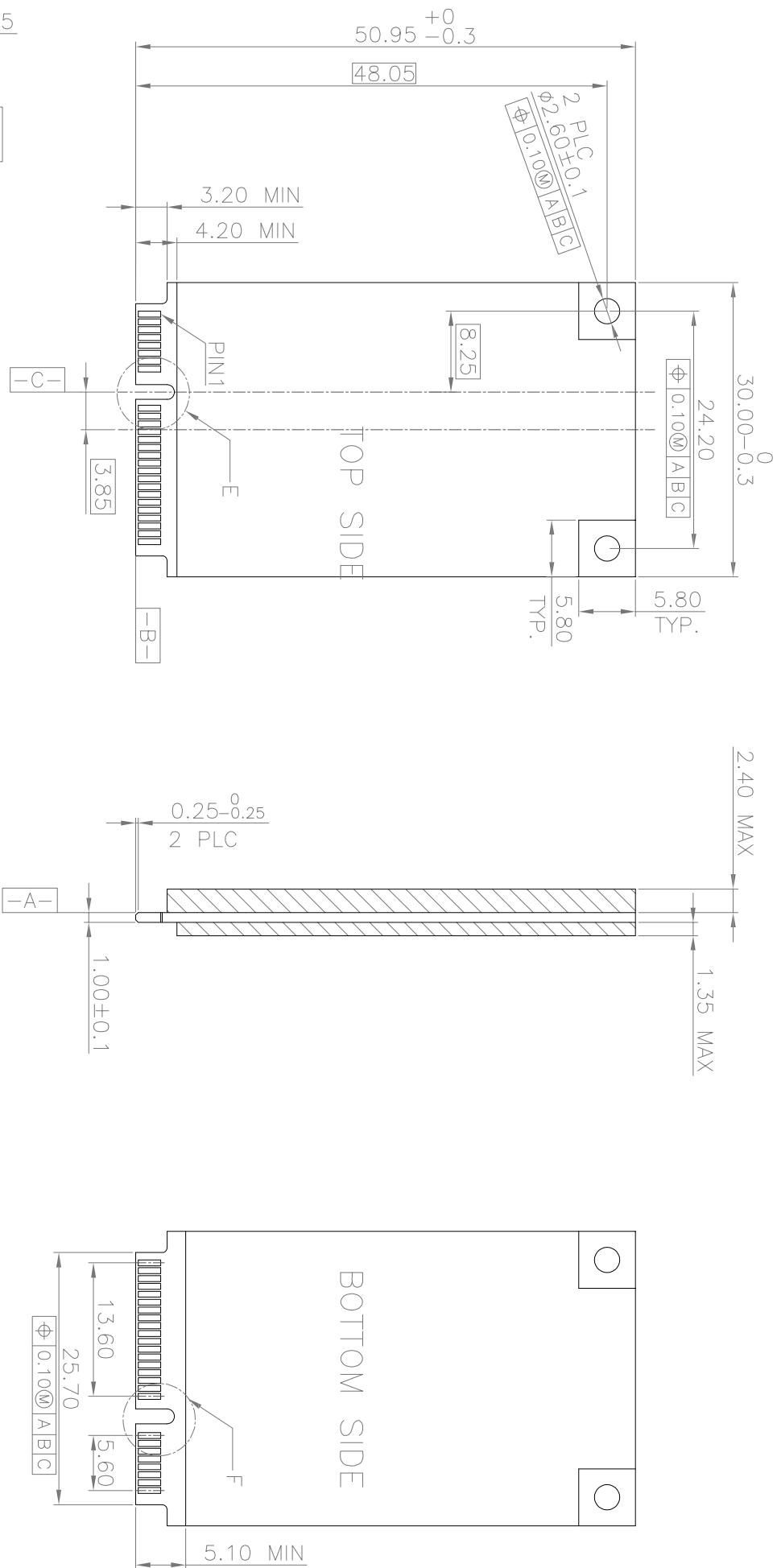

NOTES:
1.52PIN DISPLAY-MINI CARD SPECATIFICATION

NOTES:
1.PIN NUMBERING REFERENCE:
ODD PINS:TIP SIDE
EVEN PINS:BOTTOM SIDE

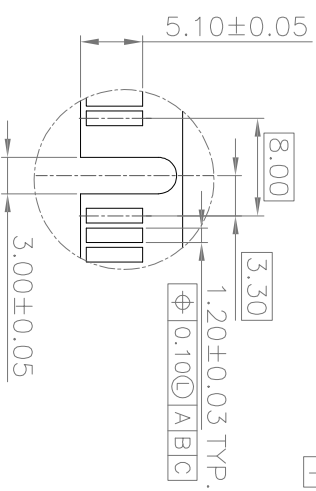

DETAIL E
SCALE 2:1

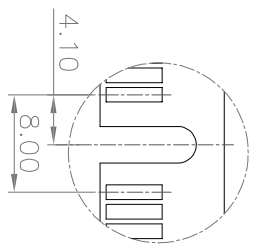

DETAIL F
SCALE 2:1

TOLERANCE	ANGLES	TITLE: Mini PCI Express 52P	
X.±0.50	X°.±2.0°	40H Connector	
X.±0.30	X°.±1.0°	PART NO. SEE TABLE	
.XX ±0.20	.XX ±	DRWN: Revly	DWG NO. EAST-MX052P-40H
.XXX ±0.10	.XXX ±	CHKD:	UNITS SCALE SHEET REV
		DATE: 2012-8-1	MM 1:1 1 OF 2 A/0

深圳市东方御业科技有限公司
Tel:0755-27155560 www.dfyycn.com

REV	LTR	DESCRIPTION	DATE	DWN
-----	-----	-------------	------	-----

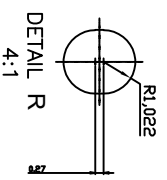
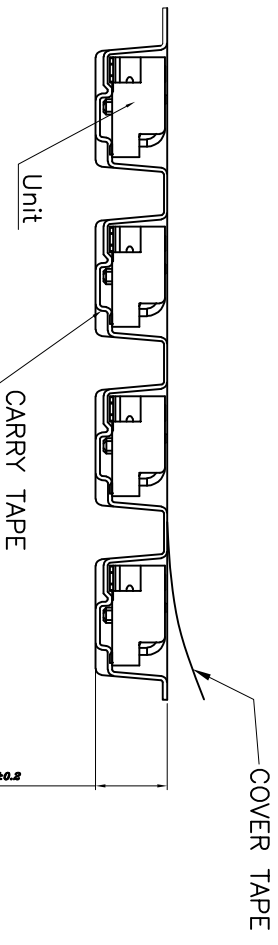
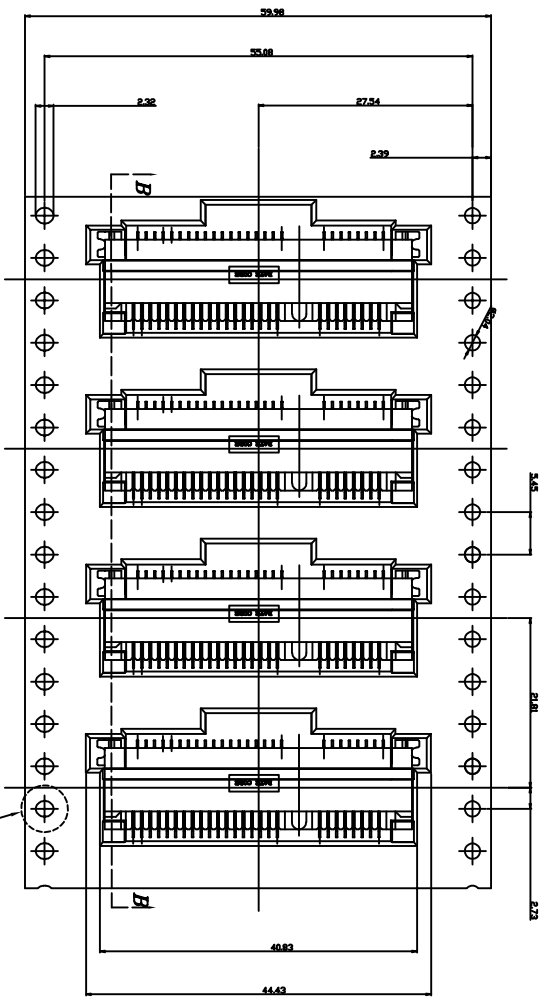
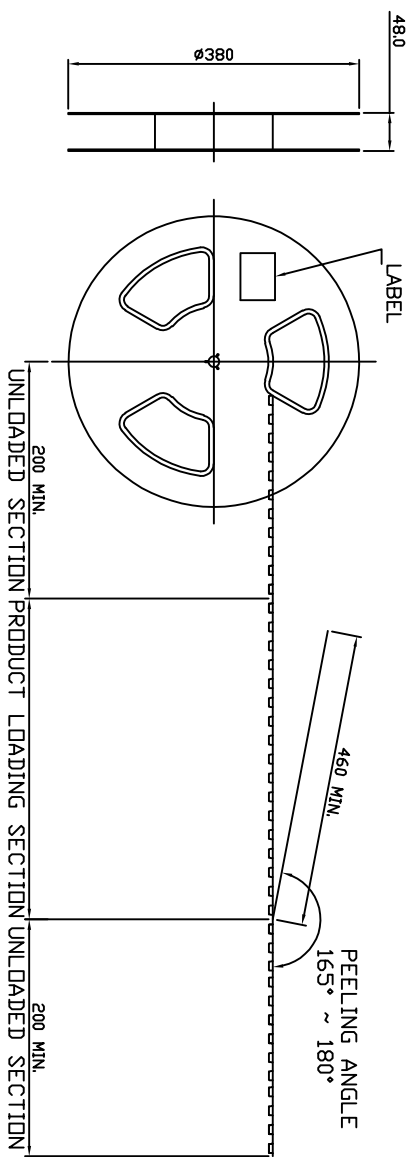

- NOTES :
1. MATERIAL :
COVER TAPE : ANTISTATIC P.S T=0.05
CARRIER TAPE : ANTISTATIC P.S T=0.40
REEL : PS UL94V-0
CARTON: CORRUGATED FIBER
 2. DIMENSION :
REEL : SEE DRAWING
SHIPPING BOX: 385X385X295mm
 3. QUANTITY : SEE TABLE
 4. PEELING RESISTANCE : 10gf~130gf (for 12~56mm)
 5. PEELING SPEED : 300mm/MINUTES

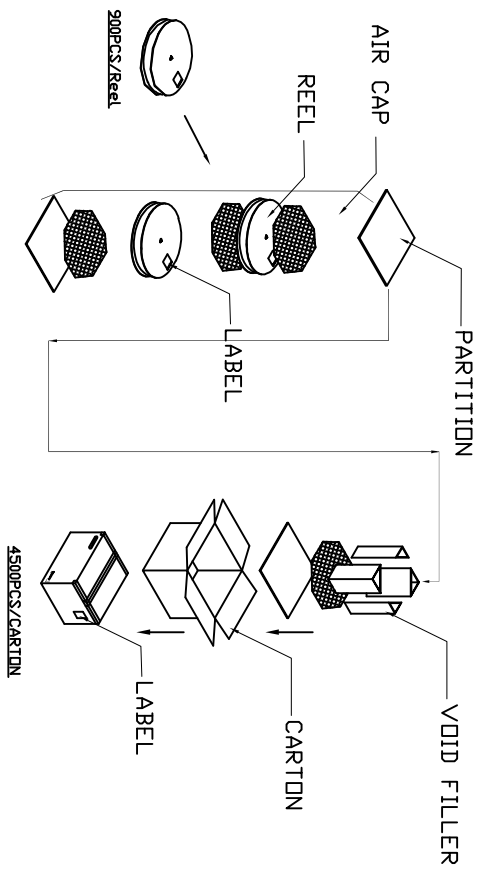

TOLERANCE	ANGLES	TITLE	
LINEAR X. ±0.50	X°. ±2.0°	Packaging for Mini PCI Express 52P	
X. ±0.30	X°. ±1.0°	5.2H Connector	
.XX ±0.20	.XX° ±	PART NO.	EAST-MX052P-52H
.XXX ±0.10	.XXX° ±	DWG NO.	
		UNITS	MM
		SCALE	1:1
		SHEET	1 OF 1
		REV	A/0

深圳市东方御业科技有限公司		DRWN:	DATE: 2012-7-31
Tel: 0755-27155560 www.dfyycn.com		Revly	